

Autonics

Weekly/Yearly Timer LE7M-2

M A N U A L



Thank you very much for selecting Autonics products.
For your safety, please read the following before using.

Caution for your safety

- ※Please keep these instructions and review them before using this unit.
- ※Please observe the cautions that follow;
- Warning** Serious injury may result if instructions are not followed.
- Caution** Product may be damaged, or injury may result if instructions are not followed.
- ※The following is an explanation of the symbols used in the operation manual.
- ⚠ caution: Injury or danger may occur under special conditions.

Warning

- In case of using this unit with machinery(Nuclear power control, medical equipment, vehicle, train, airplane, combustion apparatus, entertainment or safety device etc), it is required to install fail-safe device. It may cause a fire, human injury or damage to property.
- It should be mounted on Panel to use. It may give an electric shock.
- Do not connect, inspect and repair when power is ON. It may give an electric shock.
- Do not disassemble or modify this unit. Please contact us if it is required. It may give an electric shock and cause a fire.
- Lithium battery is used for memory protection in this product, therefore do not disassemble or burn up. It may cause an explosion.

Caution

- This unit shall not be used outdoors. It might shorten the life cycle of the product or give an electric shock.
- When wire connection, No.20AWG(0.50mm²) should be used and screw bolt on terminal block with 0.74N · m to 0.90N · m strength. It may cause a malfunction or fire due to contact failure.
- Please observe the rated specifications. It might shorten the life cycle of the product and cause a fire.
- In cleaning the unit, do not use water or an organic solvents. It may give an electric shock and fire.
- Do not use this unit at place where there are flammable or explosive gas, humidity, direct ray of the sun, radiant heat, vibration and impact etc. It may cause a fire or explosion.
- Do not inflow dust or wire dregs into the unit. It may cause a fire or malfunction.

Ordering information

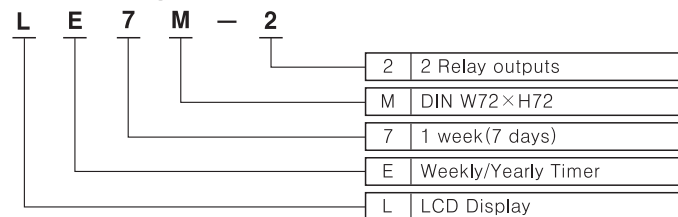

Connections

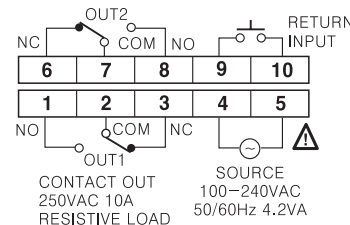

※The above specifications are changeable at anytime without notice.

Front panel identification

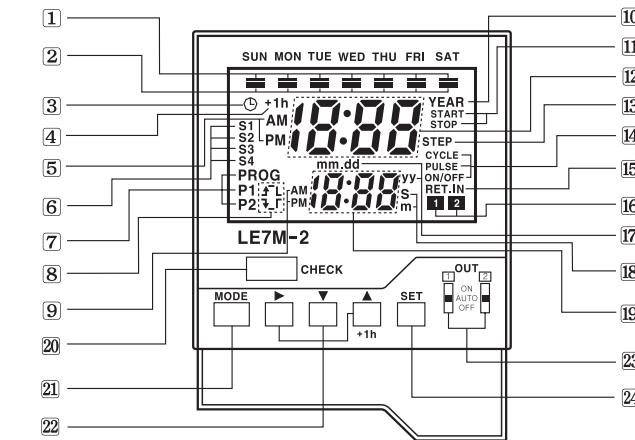

- Day cursor
- Day display
 - Light : Day is selected.
 - Light-out : Day is not selected yet.
- Current time setting display
- DST display(Daylight Saving Time)
- AM/PM display
- Season display
- Program display
- Display ON time/day, OFF time/day, ON time width, OFF time width
- AM/PM display
- YEAR display : It is lighted when set, check, modify, delete yearly program, set yearly holidays and operate yearly program.
- Yearly START/STOP day display
- Main display
- Remaining step display
- Operation mode display
- Power failure return input display
- Output mode display
- Year, month, date display
- Unit of pulse duration display
- Sub-display
- CHECK Key
- MODE Key
- Operation key
- Output selection switch
 - AUTO : Control output depending on the set program.
 - ON : Output is ON.(Operation)
 - OFF : Output is OFF.
 - ※Output 1(OUT1) and Output 2(OUT2) are selected independently.
- SET Key

Dimensions & Mounting

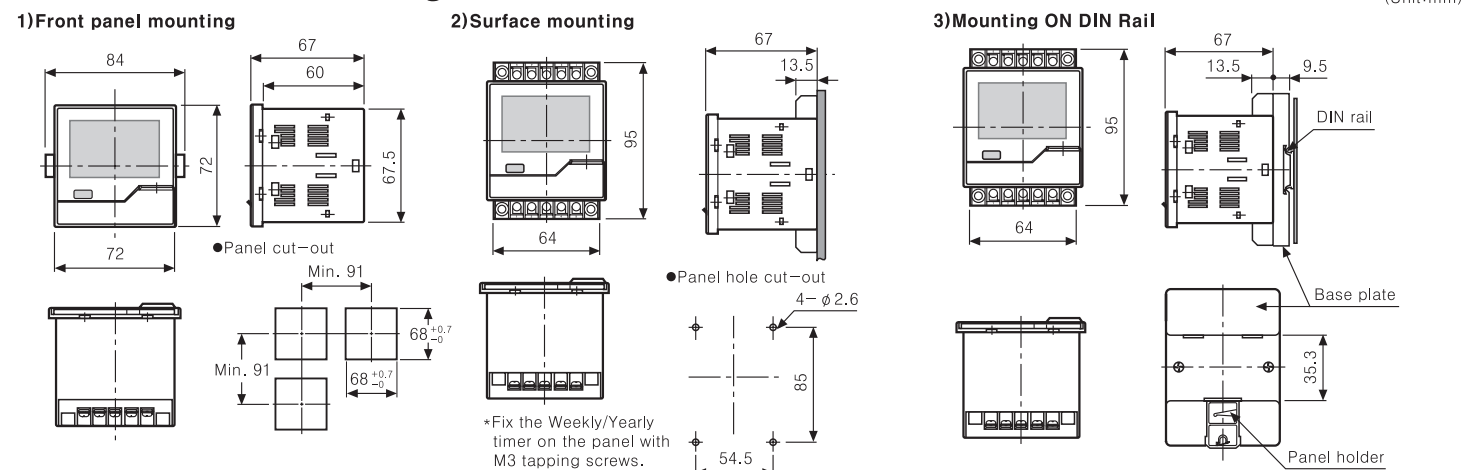

4)How to change from panel mounting type into surface mounting type

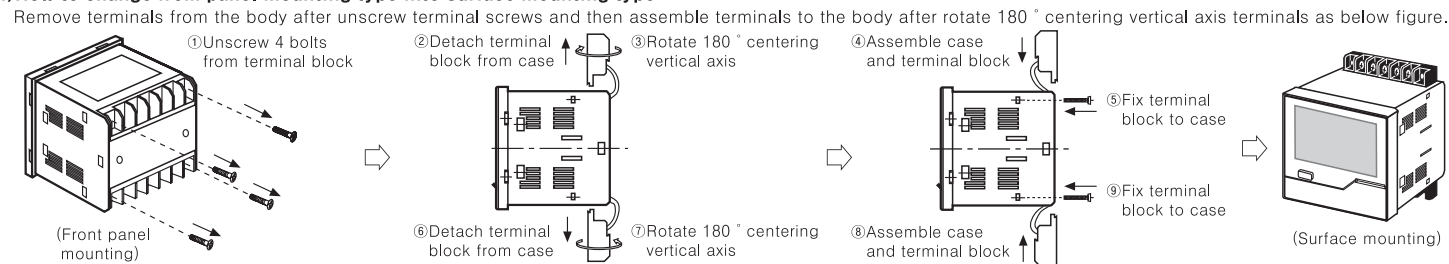

Specifications

Model	LE7M-2	
Power supply	100-240VAC 50/60Hz	
Allowable voltage range	90 to 110% of rated voltage	
Power consumption	4.2VA	
Control	Contact type SPDT(Single Pole Double Contact)	
Output	Contact capacity 250VAC 10A resistive load	
	Number of circuits Independent 2 circuits(1c × 2)	
Number of steps	48 steps for weekly, 24 steps for yearly	
Operation mode	ON/OFF mode, Cycle mode, Pulse mode	
Mounting	Front panel mounting, Surface mounting, DIN rail mounting	
Time deviation	±15sec/month(Ta:25°C) (±4sec/week)	
Temperature error	0.01% ±0.05sec	
Memory retention	Over 5 years(at 25°C)	
Insulation resistance	Min. 100MΩ(at 500VDC)	
Dielectric strength	2000VAC 50/60Hz for 1 minute	
Noise strength	±2kV the square wave noise(pulse width:1μs) by the noise simulator	
Relay life cycle	Mechanical	Min. 5,000,000 operations(Switching capacity 30 times/1 minute)
	Electrical	50,000 operations(Switching capacity 20 times/1 minute, at 250VAC 10A(resistive load) >
Ambient temperature	-10 ~ +55°C(at non-freezing status)	
Ambient humidity	35 ~ 85%RH	
Storage temperature	-25 ~ +65°C(at non-freezing status)	
Unit weight	Approx. 272g	

Functions

- Program setting and output operation**
OUT1 and OUT2 are operated depending on P1 and P2 setting.
- Terms**
 - Record : The standard unit to control output.
 - Step : The unit constructing Record
- Operation mode**
In case of program operation for Program 1 is Pulse, the operation mode of Program 1 is fixed as Pulse when add program on Program 1.(or Program 2)
In case of program operation for Program 1 is ON/OFF or Cycle, Pulse mode is not available when add program on Program 1.(or Program 2)
- Weekly ON/OFF mode**
OUT1 or OUT2 are ON at set ON time and OFF at set OFF time.
 - Min.set time unit : 1 min.
 - It is able to set ON/OFF day separately.
 - 2 steps(ON day/ON time, OFF day/OFF time) construct one Record
- Weekly Cycle mode**
Output(OUT1 or OUT2) is ON from ON Cycle operation time to OFF Cycle operation time repeatedly.
 - Set range of ON/OFF time : 1 min.-12:59
 - 3 steps(ON day/ON time, OFF day/OFF time, ON width/OFF width) construct one Record.
- Weekly Pulse mode**
Output (OUT1 or OUT2) is ON from set ON time for specified time.
 - Pulse width : 1~59sec, 1~60min
 - 2 steps(ON day/ON time, Pulse width) construct one Record.
- Yearly ON/OFF mode**
Output is ON at ON time set from START day to STOP day and OFF at set OFF.
 - 3 steps(START/STOP date, ON/OFF time) construct one Record.
- Yearly Pulse mode**
Output is ON at ON time set from START date to STOP date for specified time repeatedly(Pulse width:1~59sec, 1~60min).
 - 3 steps(START/STOP date, ON time, Pulse width) construct one Record.

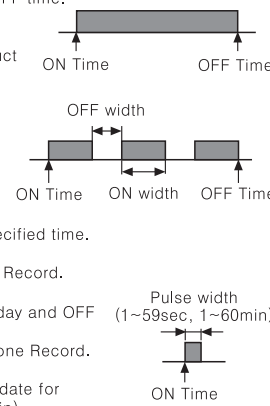

Program operation

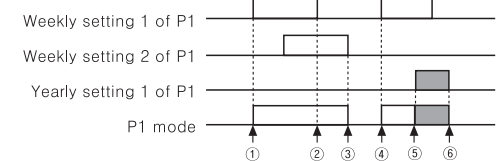

- ① ~ ② : Operated by weekly setting 1 of P1.
 - ② ~ ③ : Operated by weekly setting 2 of P1.
 - ④ ~ ⑤ : Operated by weekly setting 1 of P1.
 - ⑤ ~ ⑥ : Operated by yearly setting 1 of P1.
- (When it is changed as yearly program "START day AM 12:00(⑥)" during weekly program operation, weekly program is stopped and yearly program mode will be available. When it is changed as yearly program "Next day of STOP AM 12:00(⑥)", yearly program will be stopped.)

Display and change of next mode

- The next mode day of program1(P1) or program2(P2) is lighted on day display position and next mode time is displayed on second display part. Press [SET] + [CHECK] in RUN mode it is changed from program1 to program2 or from program2 to program1.
- It operated as ON/OFF or Cycle, mode start(ON) time and mode end(OFF) time is displayed as next mode and Pulse mode start(ON) time as next mode, in case of Pulse mode.

Power failure return mode

- After select Auto("RL") or Normal("nor") by [▲] or [▼] keys in power failure return selection LEVEL2 of setting group 2("rEt" is lighted, "RL" or "nor" are flashed.), press [SET] key to select power failure selection.
- In case of select as Auto("RL")
Output(OUT1, OUT2) is operated depending on set program when power is ON after power failure.
- In case of select Normal("nor")
Output(OUT1, OUT2) is OFF and "RET.IN" is flashed in front panel when power is ON after power failure. When power failure return is ON, "RET.IN" is lighted off and output(OUT1, OUT2) is operated depending on set program.
- Power failure return input
Input contact signal at external "Return Input terminal(⑨-⑩)" by switch or relay or press [SET] key over 3sec in RUN mode. Use reliable contacts enough to flow 0.1mA of current at 5VDC when using switch or relay.

Season switching mode

- After select ON("on") by [▲] or [▼] keys in season switching selection LEVEL2 of setting group 2("SEn" is lighted, "oFF" are flashed.), press [SET] key to select season switching selection. The previous program 1(P1) and program 2(P2) can be deleted when season switching mode is "oFF" or "on".
- In case of select as ON("on")
Weekly program is switched automatically by season switching.
- Period setting per season
 - ① Press [SET] key in period setting per season mode of setting group 2. ("SEn" is flashed, season with preset period is lighted and "START" and "STOP" are lighted.)
 - ② Advance to the flashing position of season selection among S1, S2, S3, S4 by [▲] or [▼] keys and press [SET] key.
 - ③ After set START month, date per season and press [SET] key.
 - ④ [SET] key is pressed after set STOP month, date per season, it is advanced to LEVEL1 of period setting per season. Add or adjust the period setting by [SET] key.
- Season switching selection is not available when it is set as OFF("oFF").

Daylight Saving Time

- After select Auto("RL") or Normal("nor") by [▲] or [▼] keys in power failure return selection LEVEL2 of setting group 2("dSt" is lighted, "RL" or "nor" are flashed.), press [SET] key to select Daylight Saving Time.
- In case of select as Auto("RL")
Current time will be faster as an hour when it is started and will be slower as an hour when Auto mode is finished.
- Automatic Daylight Saving Time period setting
 - ① Automatic Daylight Saving Time period setting LEVEL 1 of setting group 2. ("dSt" is flashed and "START" and "STOP" are lighted.)
 - ② Set START date(Month, date) of automatic Daylight Saving Time mode and press [SET] key.
 - ③ Set START time(AM/PM, Hour) of automatic Daylight Saving Time mode and press [SET] key. But, the minute will be fixed as 00.
 - ④ Set STOP date(Month, date) of automatic Daylight Saving Time mode and press [SET] key.
 - ⑤ Set STOP time(AM/PM, Hour) of automatic Daylight Saving Time mode and press [SET] key. But, the minute will be fixed as 00.
- In case of select as Normal("nor")
Press [+1h] key over 3sec in RUN mode, "+1h" is lighted and current time is faster as an hour and "+1h" is lighted out, current time will be slower as an hour when press [+1h] key over 3sec again.

Current time setting

- (Ex)Set the current time as 10, Mar, 2008, 5:10 PM.
- ① Advance to the current time setting mode
- ② Set Year, Month, Date
- ③ Set current time(AM, PM)
- ④ Set current time(Hour, Min.)

- When power is ON, it is advanced to "① Current time setting mode" and set current time as the above ②-④ by [SET] key.
- Current time is set up to 31, Dec, 2099.
- Check current year/month/date in RUN mode
When [▶] key is pressed over 3sec in RUN mode, it is advanced to current year/month/date display. After display current year/month/date for 3sec, it is returned to RUN mode displaying current display.

Program setting

Setting group 1

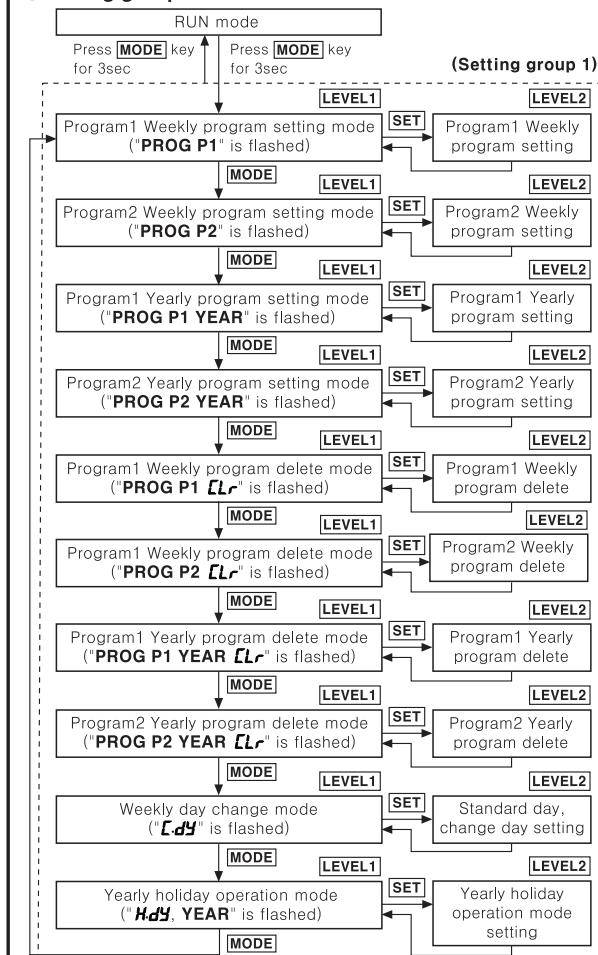

- When it is advanced to setting group 1 in RUN mode, output (OUT1, OUT2) will be OFF.
- It is returned to previous setting group 1 when power of time switch is ON again in setting group 1.
- When **MODE** key is pressed in LEVEL2 of setting group 1, current setting will be canceled and it is returned to previous LEVEL1.

Setting group 2

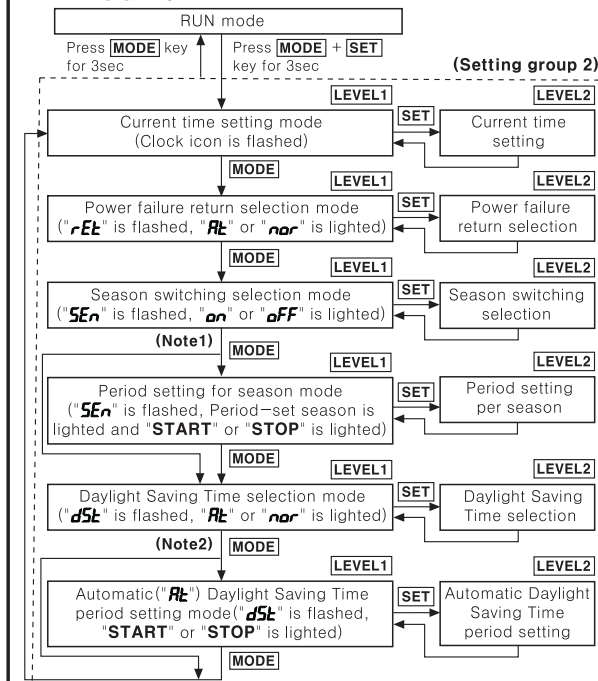

- (Note1) Season switching selection is "OFF".
- (Note2) Automatic switching selection of Daylight Saving Time is Normal ("nor").
- If it is advanced to setting group 2 in RUN mode, output(OUT1, OUT2) will be OFF.
- When power of time switch is ON again in setting group 2, it is returned to previous setting group 1.
- Front **MODE** key is pressed in LEVEL2 of setting group 2, it is returned to previous LEVEL1.
- When season switching selection is changed from "OFF" to "on" or "an" to "OFF", previous set weekly program will be deleted.

Weekly program setting

Weekly ON/OFF mode

(Ex)Output1(OUT1) is ON from Monday to Friday at 8:00 AM and OFF at 6:10 PM.

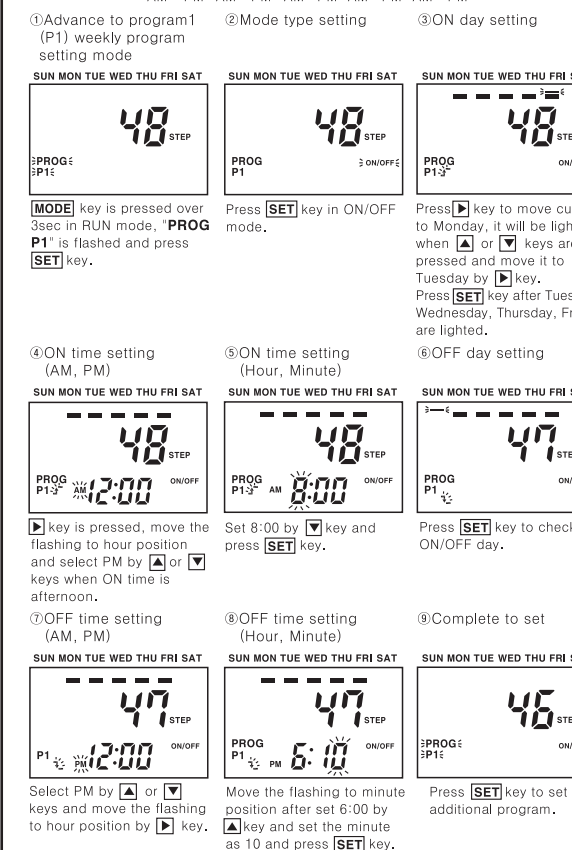
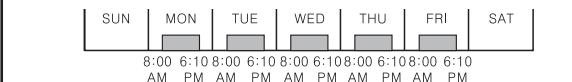

Weekly Pulse mode

Output2(OUT2) is ON for 10sec at 8:00AM from Monday to Friday during S2 season in case, period of S1, S2, S3, S4 is set.

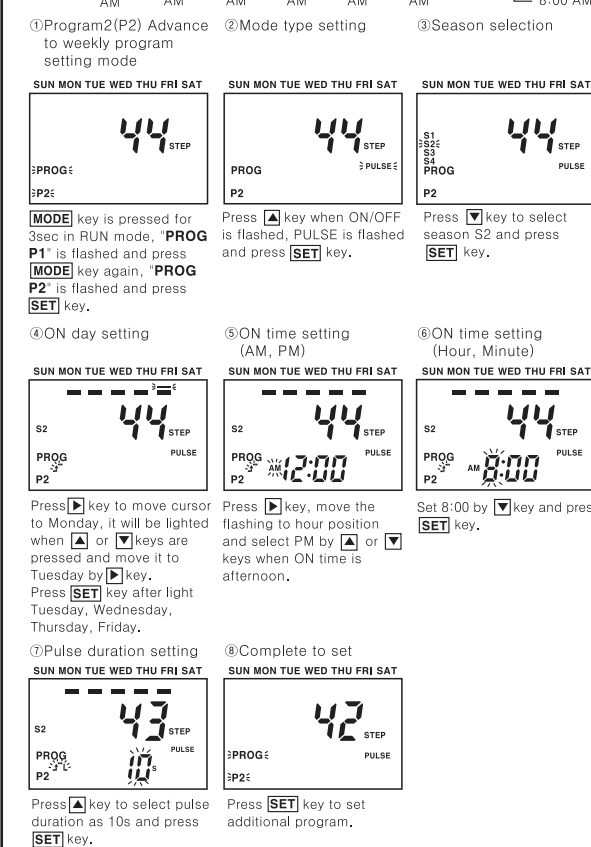

Weekly Cycle mode

(Ex)Output1(OUT1) is ON for 10min and OFF for 5min from Monday 6:00AM to Saturday 5:30PM.

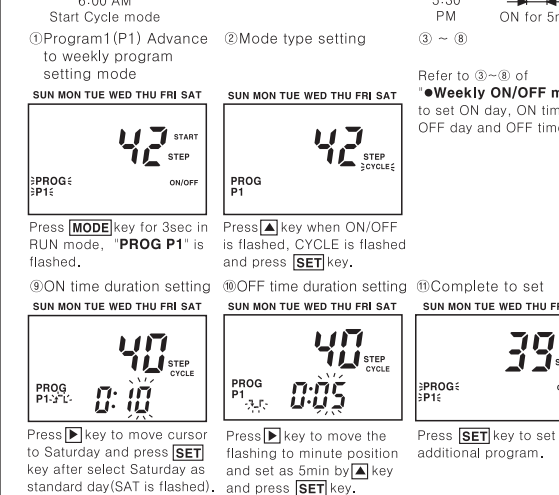

Weekly day change

When the specified day mode is required to install in other day, it is started from the set day and returned to previous program setting automatically when it is finished. It is applied to program1(P1) and program2(P2).

Weekly day change cancellation

- Change current year, month, date in current time setting mode
- Change standard day
- Delete all program in program1(P1) and program2(P2)
- Season switching

Setting

Output1(OUT1) is ON Saturday at 9:00AM and OFF at 12:00PM and it is ON 8:30AM and OFF at 6:00PM from Monday to Friday and the mode of Monday and Tuesday is operated temporarily as Saturday(standard) program.

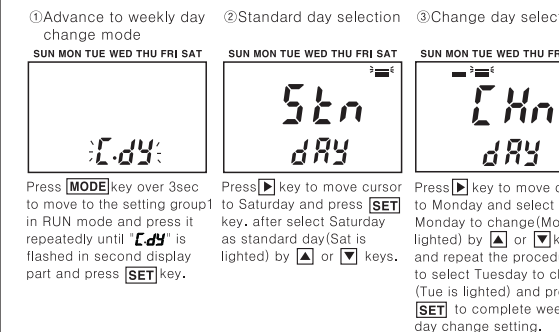

Yearly holiday mode

It is used to off the output without program adjustment during previously set yearly holiday period available from present year to 31, Dec of the next year. Designate the start date of yearly holiday and year of end date as every year ("--") to repeat the holiday mode for specified in every year.

Setting

Set every year 5, May to off the output(OUT1, OUT2).

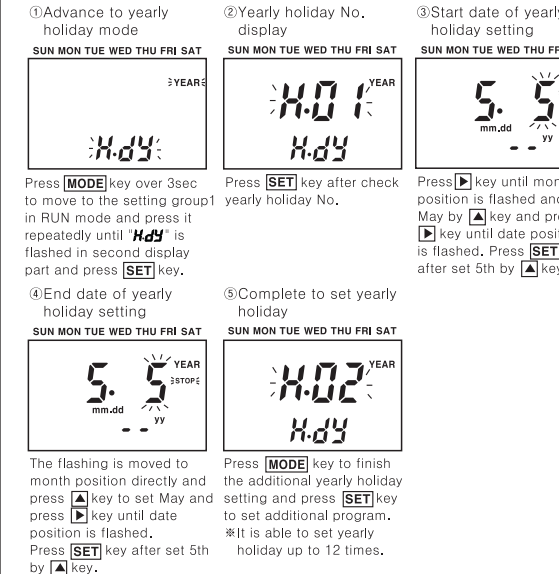

Yearly program setting

Yearly ON/OFF mode

(Ex)Output1(OUT1) is ON from every 5, Apr to 7, Apr at 9:00AM and OFF 5:10PM.

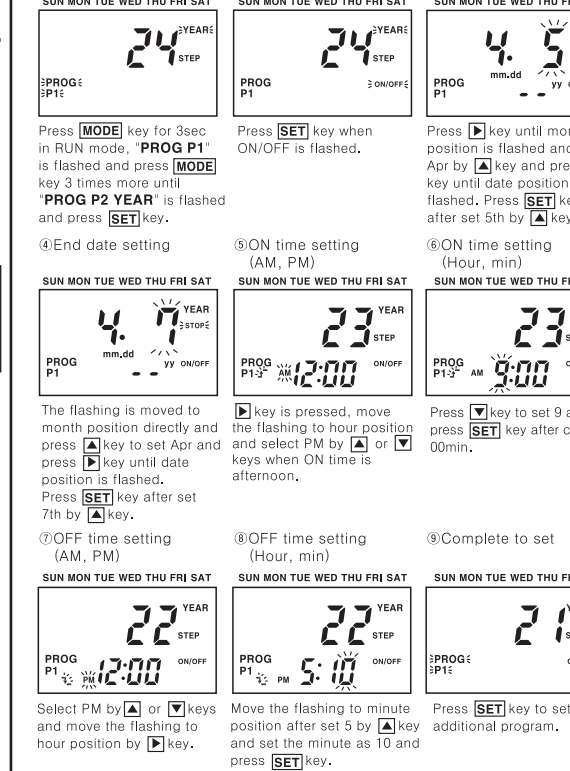
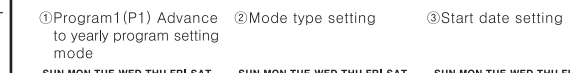

Yearly Pulse mode

(Ex)Output2(OUT2) is ON from 2, Oct, 2008 to 4, Oct, 2008 at 10:00AM and OFF after 5sec. (Present is 2007.)

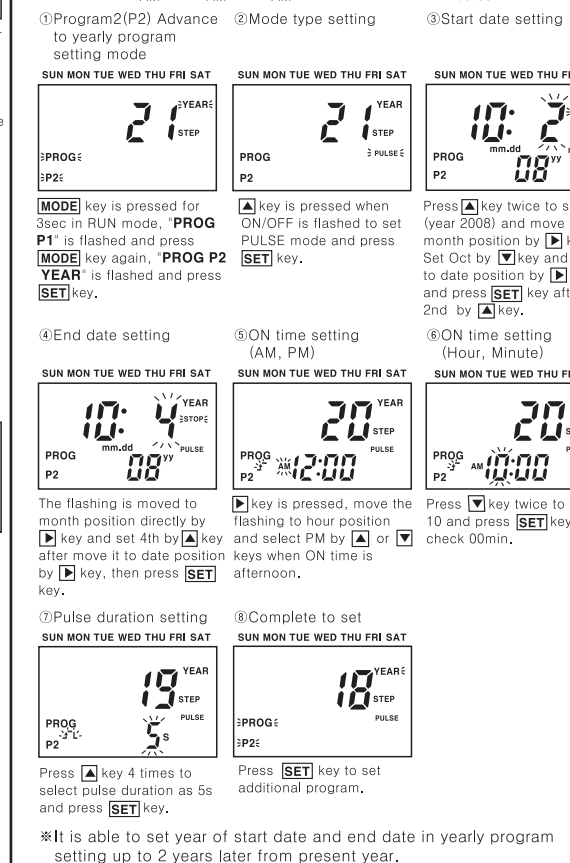

It is able to set year of start date and end date in yearly program setting up to 2 years later from present year.

Program check, modify and delete

Weekly program check, modify and delete

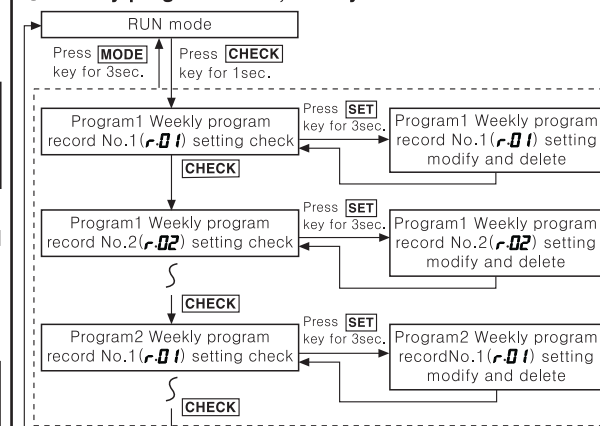

Yearly program check, modify and delete

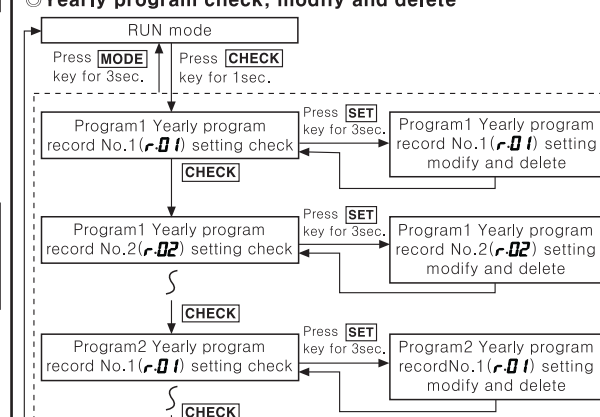

*"YEAR" is lighted when check, modify or delete yearly program.

If any key is untouched for 60sec, it is returned to RUN mode in weekly or yearly program check.

In weekly or yearly program check, it controls output depending on program setting and output is OFF in modify or delete mode.

When **MODE** key is pressed in weekly or yearly program record modify, delete stand by or delete mode, current work is cancelled and it is returned to check mode.

Weekly or yearly program record modify and delete

- Program record modify
 - When press **SET** key over 3sec in program check, "Edt" is flashed in second display part, press **SET** key.
 - It is returned to check mode when finish the modify same as the above procedure.
- Program record delete
 - When press **SET** key over 3sec in program check, "CLr" is flashed in second display part and press **SET** key.
 - Press **SET** key over 3sec when "CLr" is lighted in second display part, it is returned to program check.

Caution for using

- Please use within the rated power and apply or cut the power at once to prevent from chattering.
- When test dielectric voltage and insulation resistance of the control panel with this unit installed.
 - Please isolate this unit from the circuit of control panel.
 - Please make all terminals of this unit short-circuited.
- When control a heater, please install the thermostatic switch at load circuit.
- Installation environment
 - It shall be used indoor
 - Altitude Max. 2000m
 - Pollution Degree 2
 - Installation Category II.

It may cause malfunction if above instructions are not followed.

Major products

- PROXIMITY SENSOR
- FIBER OPTIC SENSOR
- PRESSURE SENSOR
- TIMER
- TEMPERATURE/HUMIDITY TRANSDUCER
- POWER CONTROLLER
- PANEL METER
- TACHO/LINE SPEED/PULSE METER
- DISPLAY UNIT
- SENSOR CONTROLLER
- SWITCHING POWER SUPPLY
- GRAPHIC PANEL
- STEPPING MOTOR & DRIVER & CONTROLLER
- LASER MARKING SYSTEM (CO₂, Nd:YAG)
- PHOTOELECTRIC SENSOR
- DOOR/DOOR SIDE SENSOR
- ROTARY ENCODER
- COUNTER
- TEMPERATURE CONTROLLER
- TEMPERATURE/HUMIDITY TRANSDUCER

Autonics Corporation
<http://www.autonics.com>
 Satisfiable Partner For Factory Automation

HEAD QUARTERS :
 41-3, Yonggang-dong, Yangsan-si, Gyeongsang, 659-847, Korea

OVERSEAS SALES :
 310g-402 3rd Fl., Bucheon Techno Park, 193, Yakkdae-dong, Wornn-gu, Bucheon-si, Gyeonggi-do, 420-734, Korea
 TEL: 82-32-610-2730 / FAX: 82-32-329-0728
 E-mail: sales@autonics.com